

AIR Cylinder as per ISO 15552 & CETOP RP 52 P



Features

- According to ISO 15552 & VDMA 24562
- Cylinder tube of extruded profile aluminium
- Cushioning adjustable at both ends, high energy absorption with PU
- Lubrication not necessary (maintain once started oil mist lubrication)
- Compressed air dried to a pressure dew point 3 °C - 5 °C admissible
- Operating medium: Compressed air, filtered to minimum 50 µm
- Operating pressure range 1-10 bar
- Operating Temperature range - 20 °C to + 70 °C
- Life 20,000 km, with PU Seals
- Minimum operating pressure 0.3 bar
- Speed 3 m/ sec maximum

Construction

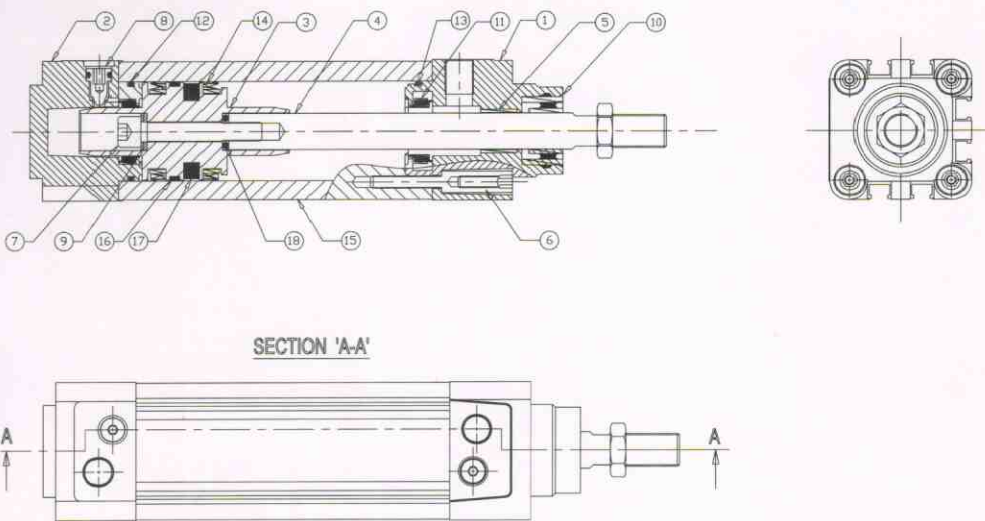

Material of Construction



Part	Material	Part No.	Part	Material	Part No.
Cylinder Tube	Anodised Aluminium	15	Cushioning Screw	M. S.	8
Covers	Aluminium	1, 2	Cushioning Seal	NBR	11
Piston rod	Stainless Steel (SS 410)	4	Rod Seal	Polyurethane	10
Piston	Aluminium	3	O Ring	NBR	18
Cover Seals	NBR	12, 13	Cover Bolts	Galvanized Steel	6
Lip Seals	NBR	14	Permanent Magnet	-	17
Piston rod guide	Self Lubricating High Polymer	5	SHC Screw	HGA Steel	7
Washer	M. S.	9	Piston Guide	High Polymer	16

Force, AIR Consumption for Double Acting Cylinder

Double acting cylinder			Force (N)									
∅	∅		Pressure (bar)									
Bore	Piston Rod		1	2	3	4	5	6	7	8	9	10
32	12	←	80	160	240	320	400	480	560	640	720	800
		→	69	138	207	276	345	414	483	552	621	690
40	16	←	126	252	378	504	630	756	882	1008	1134	1260
		→	105	211	311	422	528	633	739	844	950	1055
50	20	←	196	392	588	788	980	1176	1372	1568	1764	1960
		→	165	330	495	660	825	990	1155	1320	1485	1650
63	20	←	312	624	936	1248	1560	1872	2184	2496	2808	3120
		→	281	562	843	1124	1405	1686	1967	2248	2529	2810
80	25	←	503	1006	1509	2012	2515	3018	3521	4024	4527	5030
		→	453	903	1359	1812	2265	2718	3171	3624	4077	4530
100	25	←	785	1570	2355	3140	3925	4710	5495	6280	7065	7850
		→	736	1473	2209	2946	3682	4419	5156	5892	6639	7365

Remark 1 Max. 1 bar is necessary to deal with the mechanical friction

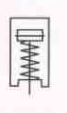
Remark 2 To obtain a uniform speed, the load degree is not to be chosen over 60%

Single Acting Cylinder			
Spring Forces (N)			<p>Other spring forces can be provided, consult HPC</p> <p>Remark The given spring forces are intended only for the return of the piston and piston rod.</p> <p>For model E and EA spring forces remains same, cushioning not available on spring side, flow control not possible on spring side.</p>
∅ Bore			
32	30	80	
40			
50	75	130	
63			
80	150	320	
100			

Air consumption - dm ³ A.N.R./cm stroke A.N.R. = dm ³ under Norm-conditions										
∅	1 bar	2 bar	3 bar	4 bar	5 bar	6 bar	7 bar	8 bar	9 bar	10 bar
32	0.017	0.025	0.033	0.041	0.049	0.057	0.065	0.073	0.081	0.089
40	0.026	0.038	0.05	0.063	0.076	0.088	0.1	0.113	0.126	0.139
50	0.04	0.059	0.079	0.099	0.118	0.138	0.158	0.177	0.197	0.22
63	0.063	0.094	0.125	0.156	0.188	0.219	0.25	0.281	0.312	0.343
80	0.101	0.151	0.202	0.252	0.302	0.352	0.403	0.453	0.503	0.554
100	0.158	0.236	0.315	0.393	0.472	0.55	0.629	0.708	0.786	0.865
125	0.246	0.369	0.492	0.615	0.738	0.861	0.984	1.107	1.230	1.353
160	0.403	0.604	0.805	1.006	1.207	1.408	1.609	1.81	2.011	2.212

AIR Cylinder as per ISO 6431 & CETOP RP 52 P

Ordering Code



1 Type	SPC		
2 Model	D	Double Acting	
	E	Single Acting, Spring at Rod Side	
	EA	Single Acting, Spring at Rear Cover	
3 Piston Rod Conn.	O	Outer Thread	
	F	Flexible Connection Piece	
	S	Fork	
	W	Ball and Socket Joint	
	LN	Extra Lock Nut	
	4 Sp. Model	OO	Standard
	AV	Viton Seals	
	BG	Bellows	
	CL	Polyurethane Coating	
	DS	Double-ended Piston Rod	
	MAE	Piston with Permanent Magnet Ring	
	MAE 1	One Reed Switch	
	MAE 2	Two Reed Switches	
	ZR	304/ 316 Material Piston Rod 1.4305 (18/ 8)	
	SU	Other, to define special models	
5 Cylinder Mount.	O	4x Internal Thread Front and Rear	
	MS1	2 Pedestals	
	MF1	Front Flange	
	MF2	Rear Flange	
	GA	Rear Hinge Cardan	
	LG	Counter Hinge for GA	
	MP2	Rear Hinge	
	LB 2	Counter Hinge for MP2	
	MP 3	Rear Trunion Cardan	
	MP 4	Rear Hinge	
	MT 4	Central Trunion	
	MT 5	Front Trunion	
	MT0	Bearing for MT4 and Mt5	
6	BORE	32	
		40	
		50	
		63	
		80	
		100	
		125	
		160	
7	STROKE	3500mm	Max. D
8		300mm	Max. E
		300	Max. EA

Ordering Example

- SPC-D-0-00-0-32/ 100
Double acting Cylinder with 32mm Bore and 100mm stroke
- SPC-E-S-AV-MF1-40/175
Single acting Cylinder with 40mm Bore and 175mm stroke, Spring at rod side, with fork on the Piston Rod, Viton seals for high temperature application and front flange mounting

Ordering Example Mountings

MP2-40
Rear trunion for dia cylinder
* Please note, the mountings may be supplied loose along with cylinder

**Piston ROD Connection
O - Outer Thread with Locknut**

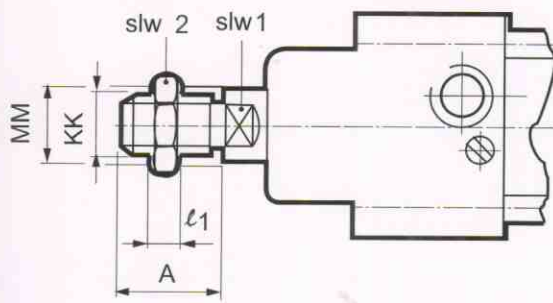

Ø	A	KK	MM	slw2
	0/0.5		h9	
32	22	M10 x 1.25	12	10
40	24	M10 x 1.25	16	13
50	32	M16 x 1.5	20	17
63	32	M16 x 1.5	20	17
80	40	M20 x 1.5	25	22
100	40	M20 x 1.5	25	22

F-Flexible Connection PIPE + NUT

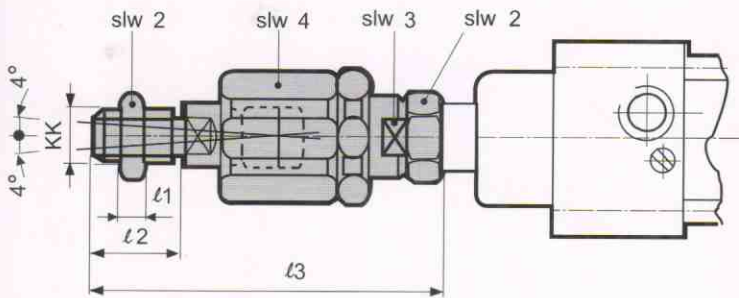

Ø	KK	l1	l2	l3	slw2	slw3	slw4
				min-max			
32	M10 x 1.25	5	20	78 - 82	17	19	30
40	M12 x 1.25	6	24	85 - 88	19	19	30
50	M16 x 1.5	8	32	116 - 119	24	30	41
63	M16 x 1.5	8	32	116 - 119	24	30	41
80	M20 x 1.5	10	40	136 - 140	30	30	41
100	M30 x 1.5	10	40	136 - 140	30	30	41

S - FORK + PIN + NUT

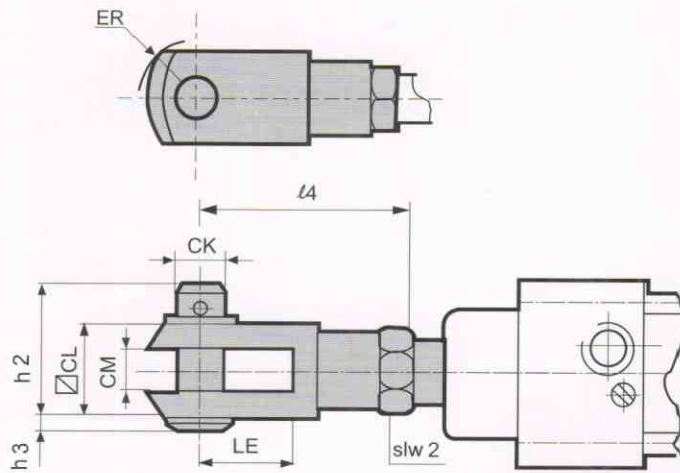

Ø	CK	CL	CM	ER	LE	h2	h3	l4	slw2
	h11		+0.15, max. 0.5	Min.					
32	10	20	10	13	20	28	2	48 - 52	18
40	12	24	12	17	24	35	3	58 - 61	27
50	16	32	16	21	32	45	3	77 - 80	27
63	16	32	16	21	32	45	3	77 - 80	27
80	20	40	20	27	40	55	4	96 - 100	33
100	20	40	20	27	40	55	4	96 - 100	33

W - BALL & SOCKET JOINT + NUT

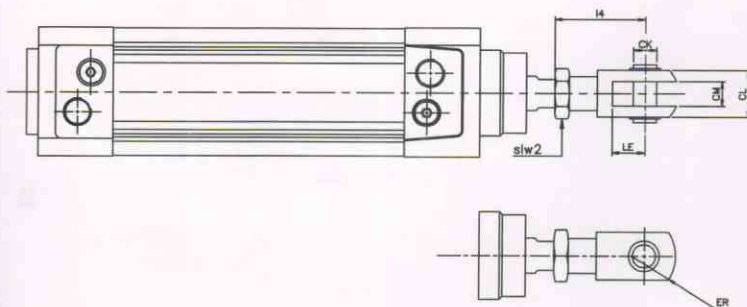

Ø	CK	CL	CM	ER	LE	l4	slw2
32	10	20	10	13	20	48 - 20	18
40	12	24	12	17	24	58 - 61	21
50	16	32	16	21	32	77 - 80	27
63	16	32	16	21	32	77 - 80	27
80	20	40	20	27	40	96 - 100	33
100	20	40	20	27	40	133 - 138	41

Note: Due to continuous developments dimensions are subject to change without notice.



Piston ROD Connection

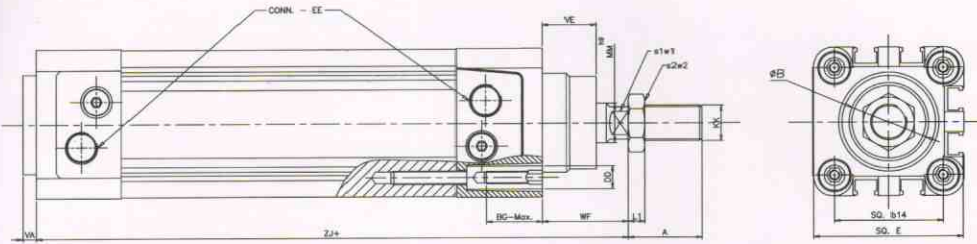

Ø	A	ØB	BG max.	DD	E max.	EE	KK	MM	b14	VA	VE	WF	ZJ	L1	slw1	slw2
32	22	30	16	M6	44.5	G 1/8	M10 x 1.25	12	32.5	4	18.5	26	125	6	10	17
40	24	35	16	M6	53	G 1/4	M12 x 1.25	16	38	4	21.5	31	136	8	14	19
50	32	40	20	M8	63	G 1/4	M16 x 1.5	20	46.5	4	27	37	144	8	17	24
63	32	45	21	M8	74	G 3/8	M16 x 1.5	20	56.5	3	29.5	37	159	8	17	24
80	40	45	22	M10	92	G 3/8	M20 x 1.5	25	72	4	35	51	176	10	22	30
100	40	55	22	M10	109	G 1/2	M20 x 1.5	25	89	4	28	57	193	10	22	30

Cylinder Mounting Ms1 - 2 Pedestals

MF1 - FRONT FLANGE + SOCKET HEAD SCREWS

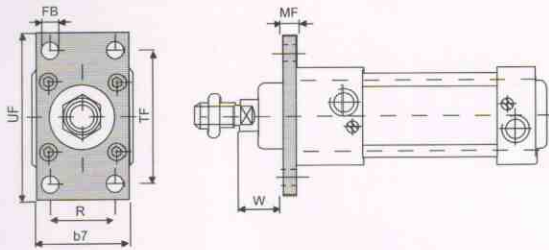

Model	FB H13	MF	R Js14	TF Js14	UF max.	ZF	b7 max.
MF-32	7	10	32	64	80	131	50
MF-40	9	10	36	72	90	146	54
MF-50	9	12	45	90	110	156	65
MF-63	9	12	50	100	120	171	75
MF-80	12	15	63	126	150	190	100
MF-100	14	15	75	150	172	205	120
MF-125	16	20	90	180	220	245	140
MF-160	18	20	115	230	275	280	175

MF is same for front & back mounting

1. MF - MF 1 - MF 2

MS1 - PEDESTAL (2 Nos.) + SOCKET HEAD SCREWS

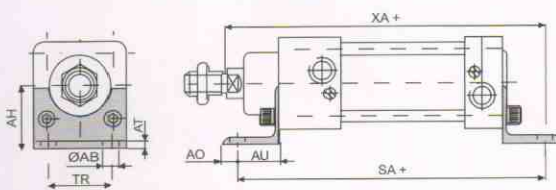

Model	AB H13 ±0.5	AH	AO	AT	AU	SA ±0.3	TR	XA
MS1-32	7	32	6	4	24	143	32	145
MS1-40	9	36	7	5	28	162	36	164
MS1-50	9	45	8	6	32	171	45	176
MS1-63	9	50	8	6	32	186	50	191
MS1-80	12	63	14	6	41	211	63	216
MS1-100	14	71	14	6	41	222	75	231
MS1-125	19	90	20	8	45	253	90	272
MS1-160	18	115	20	10	60	302	115	323

Sp. Cylinder with GA

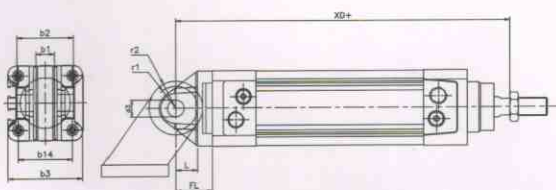

Ø	FL	L	b1	b2	b3	d3	b14	r1	r2	XD
32	22	13	14	34	45	10	32.5	10	16	147
40	25	17	16	40	54	12	38	12	17	161
50	27	16	21	45	65	16	46.5	14	21	171
63	32	20	21	51	75	16	56.5	16	22	191
80	36	23	25	56	93	20	72	18	27	212
100	41	25	25	75	110	20	89	21	30	234

Note : Due to continuous developments dimensions are subject to change without notice.

**Cylinder Mountings
LG - Cardan Counter Hinge**

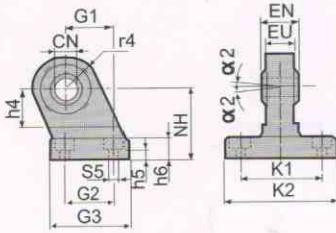

Ø	CN H7	EN 0/0.1 max.	EU max.	G1 Js14	G2 Js14	G3 max.	K1 Js14	K2 max.	NH Js15	S5 H13	h4 min.	h5	h6 max.	r4 max.	α2
32	10	14	10.5	21	18	33	38	52	32	5.5	22	2.4	8	16	7
40	12	16	12	24	12	37	41	55	36	5.5	20	4.4	10	17	6
50	16	21	15	33	30	47	50	66	45	6.6	22	5.3	12	22	8
63	16	21	15	37	35	52	52	68	50	6.6	27	5.3	12	27	7
80	20	25	18	47	40	62	66	87	63	9	31	5.1	14	27	10
100	20	25	18	55	50	72	76	97	71	9	38	6.1	15	30	9

Mp2 - Female Hinge Rear

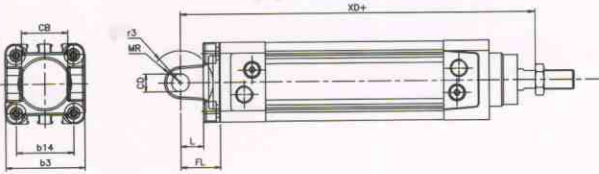

Ø	FL	L	CD	CB	MR	b3	r3	XD
32	22	13	10	26	11	45	12	147
40	25	15	12	28	13	54	15	161
50	27	16	12	32	13	65	15	171
63	32	20	16	40	17	75	20	191
80	36	23	16	50	17	93	20	212
100	41	23	20	60	22	110	25	234

Lb2 - Counter Hinge for MP2

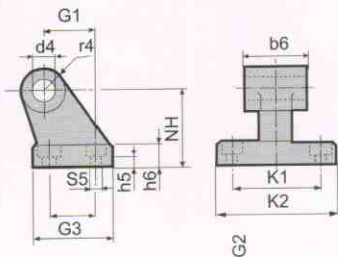

Ø	G1 JS14	G2 JS14	G3 max.	K1 max.	K2 JS15	NH H13	S5 0/-4.0	b6 H9	d4	h5 max.	h6 max.	r5
32	21	18	31	38	51	32	5.5	28.8	10	2.3	8	10
40	24	22	35	41	54	36	5.5	27.8	12	4.3	10	11
50	33	30	45	50	65	45	6.6	31.8	12	5.2	12	13
63	37	35	50	52	67	50	6.6	39.8	16	5.2	12	15
80	47	40	60	66	86	63	9	49.8	16	5	14	15
100	55	50	70	76	96	71	9	59.8	20	6	15	19

MP3

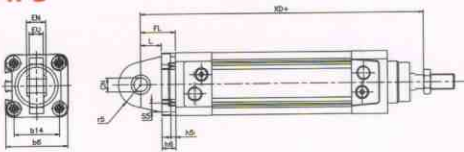

Ø	FL	L	EU	EN	CN	h6	S5	h5	r5	b14	b6	XD
32	22	13	10	14	10	10	7	3.5	16	32.5	45	147
40	25	15	12	16	12	10	7	3.5	18	38	54	161
50	27	16	16	21	16	12	9	3.5	22	46.5	65	171
63	32	20	16	21	16	12	9	5.5	27	56.5	75	191
80	36	23	20	25	20	13	11	2.5	27	72	93	212
100	41	25	18	25	20	15	11	4.5	30	89	110	234

MP4

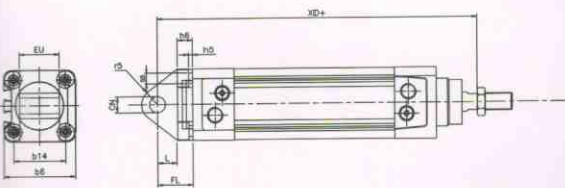

Ø	FL	L	EU	CN	h6	S5	h5	r5	b14	b6	XD
32	22	12	25	10	10	6	3.5	10	32.5	45	147
40	25	14	27	12	9	7	2	10	38	54	161
50	27	15	31	12	12	9	3	13	46.5	65	171
63	32	19	39	16	12	9	3	15	56.5	75	191
80	36	22	49	16	14	10	5	15	72	93	212
100	41	24	59	20	15	10	6	19	89	110	234

Note : Due to continuous developments dimensions are subject to change without notice.

**Cylinder Mountings
MT 4 - Central Trunnion**

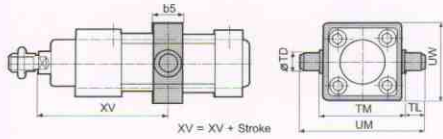

Ø	TD e9	TL h14	TM h14	UM	UW max.	XV min. max.	b5 max.
32	12	12	54	79	65	57- 89+	16
40	16	16	63	95	71	74- 104+	21
50	16	16	75	107	92	81 - 106+	21
63	20	20	90	130	102	82 - 108+	26
80	20	20	110	150	122	102 - 126+	31
100	25	25	132	182	143	107 - 129+	41

Mt5 - Front Trunnion

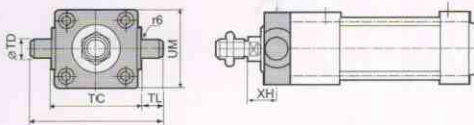

Ø	TC h14	TL e9	TL h14	UN	UT	XH	r6
40	63	16	16	60	95	20	1.5
50	75	16	16	65	107	25	1.6
63	90	20	20	75	130	25	1.6
80	110	20	20	100	150	32	1.6
100	132	25	25	110	182	32	2

MTO - Counter Hinge for Mt4 & MT5

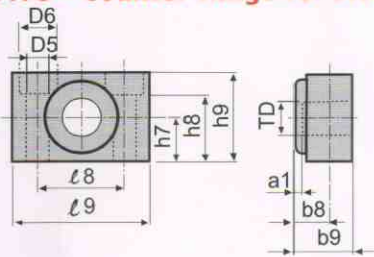

Ø	a1	B8	b9	d5	d6	h7	h8	h9	8	9	TD H8
40	1.7	12	21	9	15	18	27	36	36	55	16
50	1.7	12	21	9	15	18	27	36	36	55	16
63	1.7	13	23	11	18	20	29	40	42	65	20
80	1.7	13	23	11	18	20	29	40	42	65	20
100	2	16	28.5	14	20	25	37	50	50	75	25

**Dimension for Special Models
DS - Double Ended Piston Rod**

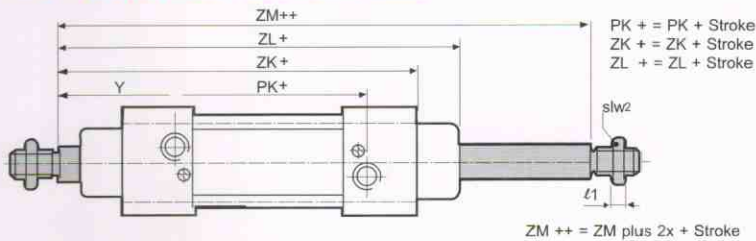

Ø	PK	T	ZK	ZL	ZM
32	73	40	128	146	154
40	73	54	149	170	179
50	76	59	158	185	195
63	87	56	162	189	199
80	92	74	194	227	240
100	110	69	197	235	248

BG - Bellows

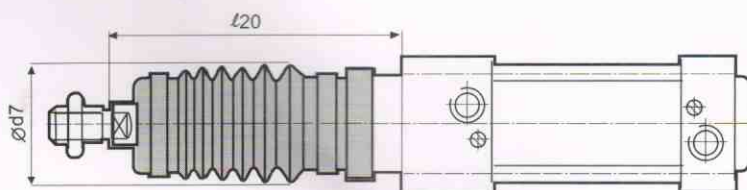

Ø	l at stroke			Bellow Max. d7
	Bore	5-250	251-500	
32	126	226	326	Ø50
40	130	230	330	Ø50
50	137	237	337	Ø50
63	137	237	337	Ø50
80	146	246	346	Ø60
100	150	250	350	Ø60

Note: Due to continuous developments dimensions are subject to change without notice.